

[abelwood.com.au](http://abelwood.com.au)

[@abelwoodtasoak](https://www.instagram.com/abelwoodtasoak)

# NSFP Complete Product Guide



**nsfp**

Neville Smith  
Forest Products



**ABELWOOD**

TASMANIAN OAK

**Woodsmith™**



# Contents



## Neville Smith Forest Products (NSFP) 3

 About NSFP	3
 Sustainability	7

## Abelwood Product Range 8

 About Abelwood	9
 Dressed All Round (DAR) Hardwood	10
 Hardwood Flooring	15
 Architrave Mouldings	17
 Internal Wall and Ceiling Lining	20
 Door Jamb	22
 Fine Mouldings	24

## Woodsmith Product Range 39

 About Woodsmith Engineered Flooring	40
 Engineered Flooring Product Range	42





# NSFP is one of the largest and most advanced processors of sustainable regrowth forest & wood products in Australia.

Neville Smith Forest Products (NSFP) is a family owned and vertically integrated enterprise operating within Tasmania since 1924 and specialising in Tasmanian Oak, one of the world's most beautiful and durable cool climate timbers.

NSFP's core business of processing and manufacturing high value appearance grade timber products

for the interior design and home decor market is one of the largest in Australia, supplying both domestic and overseas markets under the Abelwood and Woodsmith brands.

These businesses operate with a collective goal of maximising the value of Tasmania's most sustainable and renewable resource: regrowth Tasmanian Oak timber.

[abelwood.com.au](http://abelwood.com.au)

 [@abelwoodtasoak](https://www.instagram.com/abelwoodtasoak)

NSFP operates two forest and wood processing facilities in tasmania and distribution centres in both Victoria and Tasmania



**Launceston  
Dry Mill**



**Huon  
Green Mill**



**Melbourne  
Distribution Centre**





**All NSFP sites are PEFC Certified (Chain of Custody).**



ORIGINAL

TASMANIAN  
TIMBER™





# From Tasmania to the world since 1924.

The Neville Smith story is one of bush pioneering, human endeavour, technical achievement, and resolute vision; all intertwined with the adaptability to stay relevant over the course of nearly a 100-year business venture, to evolve into what is now one of Australia's largest hardwood processing companies.

Family run since 1924, NSFP's core business is processing and manufacturing high value appearance grade timber products for the interior design and home decor market. NSFP supplies both domestic and overseas markets with the finest in Tasmanian Oak flooring, architraves, mouldings, DAR products, and engineered flooring - distributed under the Abelwood and Woodsmith brands.

These businesses sit under the longstanding NSFP umbrella and operate with a collective goal of maximising the value of Tasmania's most sustainable and renewable resource: regrowth Tasmanian Oak timber.

NSFP's Tasmanian footprint consists of two individual forest and wood processing businesses, located at each end of the state in Tasmania, providing over one hundred jobs to the local economy.

The purpose-built green mill, located in the Southern Forest (south of Huonville) is designed to process smaller regrowth hardwood logs, whilst the Millworks operation in the north of the state (Launceston) specialises in the drying, reconditioning and machining of the green timber sourced from the southern green mill.

Whilst Tasmania's Oak resources are limited, NSFP's enthusiasm and optimism for the future of this renewable Tasmanian resource is unlimited.

Through a commitment to innovation, design and value-adding, NSFP plan to grow the profile and value of Tasmanian Oak as well as the broader Tasmanian forestry community.

That's a bright future every Tasmanian can look forward to.

# Committed to the timber industry since 1924.

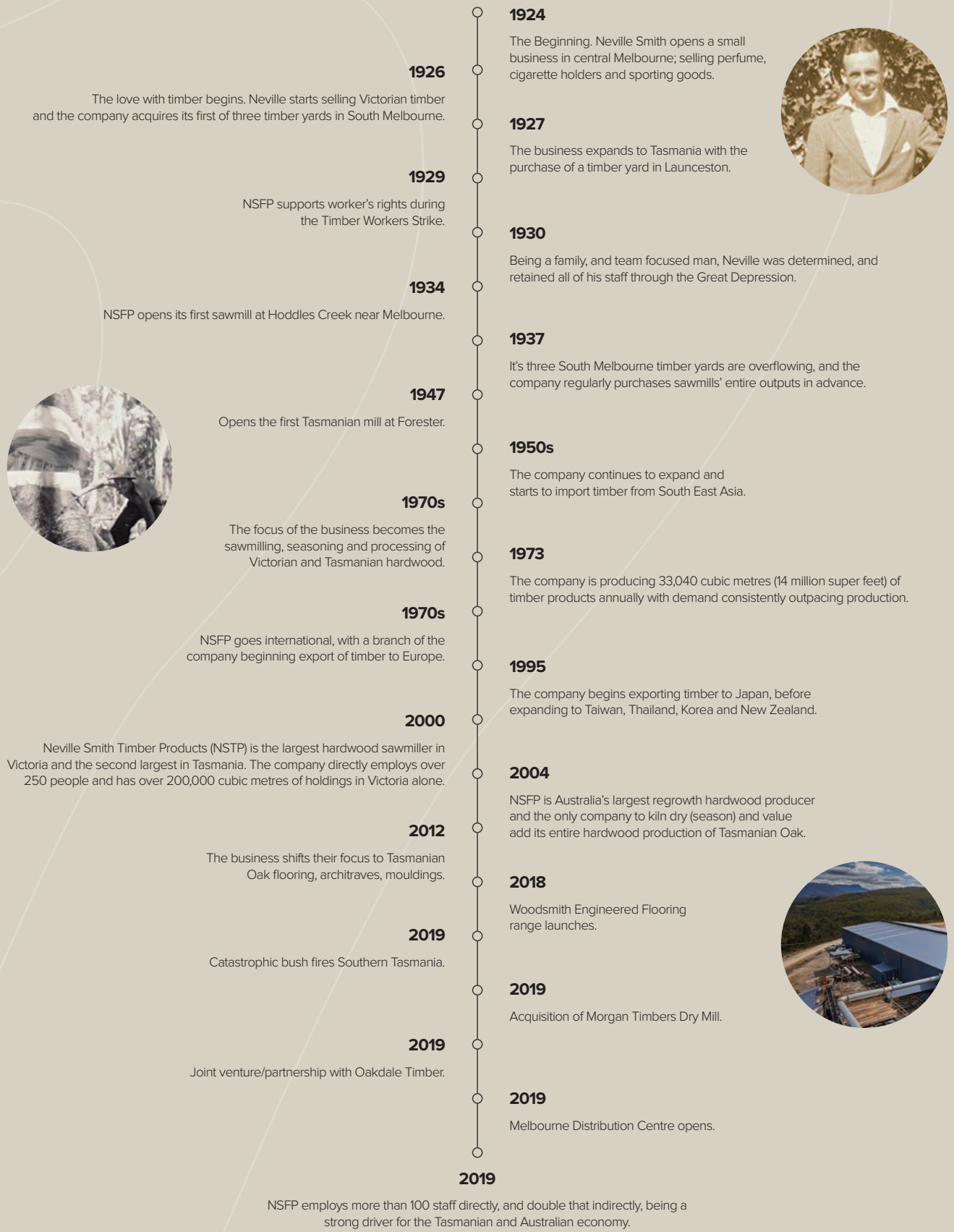



# Environmental credentials protecting our natural resource for generations to come.

NSFP was one of the first companies within the timber industry to support environmentally responsible and sustainable harvesting and to work with environmental groups to achieve these outcomes, an approach which continues to this day.

- Neville Smith Forest Products prides itself on its environmental values and management approaches including the commissioning of a wood pellet manufacturing facility resulting in zero waste at it's Mowbray dry mill.
- It was the first company in Australia to chip instead of burn end dockings.
- NSFP was one of the first groups in Australia to harvest, process, and value add younger regrowth logs from non-sensitive areas.
- The first company to value add its entire hardwood production Tasmanian Oak.

A new era of waste reduction and value-adding at every step of the production process.

NSFP's commitment to waste-reduction results in a continual review of its operations to search for new ways to reduce waste and create additional value.

**All NSFP sites are PEFC Certified (Chain of Custody).**



ORIGINAL  
TASMANIAN  
TIMBER™







# ABELWOOD

TASMANIAN OAK

## Abelwood Product Range



Dressed All Round (DAR) Hardwood



Hardwood Flooring



Architrave Mouldings



Internal Wall and Ceiling Lining



Door Jambs



Fine Mouldings



# More Australians are discovering the natural beauty of Abelwood Tasmanian Oak.

More architects, builders and designers choose Abelwood Tasmanian Oak hardwood because of its workability, consistent grain and natural blond tones.

It perfectly complements the modern Australian design aesthetic and is trusted to perform year in, year out.

Abelwood Tasmanian Oak by NSFP offers the highest of finishes across all its products making them ready for a range of decorative options to suit your home.

Every piece of Abelwood Tasmanian Oak is sourced from only sustainably managed and PEFC certified Tasmanian regrowth forests, giving you a beautiful natural product whilst protecting this unique Tasmanian resource for generations to come.

[abelwood.com.au](http://abelwood.com.au)

 [@abelwoodtasoak](https://www.instagram.com/abelwoodtasoak)



**Decorative**



**Hardwood Flooring**



**Lining**



**Fine Mouldings**





# Abelwood Tasmanian Oak Dressed All Round (DAR) Hardwood

Abelwood Tasmanian Oak is prized for its beauty, strength, stability, workability and staining qualities and used extensively in general joinery and specialised cabinetry and furniture applications.

Tasmanian Oak is light in colour, varying from straw to reddish brown with intermediate shades of cream to pink. It is recognised for its excellent staining qualities, which allow ready matching with other timbers, finishes or furnishings.

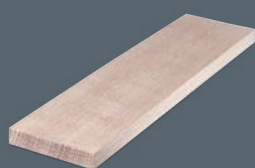

12mm DAR



19mm DAR



32mm DAR



42mm DAR













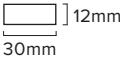

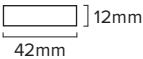

# Dressed All Round (DAR) Hardwood

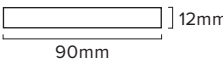
## 12mm Tasmanian Oak Hardwood

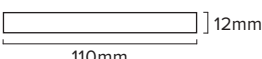
**SE** = Select Grade

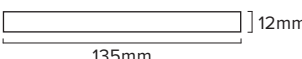
**ST** = Standard Grade

Product code	Size	Profile	3D render
<b>SE:</b> TODARSE030012 <b>ST:</b> TODARST030012	30 x 12mm	 12mm 30mm	
<b>SE:</b> TODARSE042012 <b>ST:</b> TODARST042012	42 x 12mm	 12mm 42mm	
<b>SE:</b> TODARSE065012 <b>ST:</b> TODARST065012	65 x 12mm	 12mm 65mm	
<b>SE:</b> TODARSE090012 <b>ST:</b> TODARST090012	90 x 12mm	 12mm 90mm	
<b>SE:</b> TODARSE110012 <b>ST:</b> TODARST110012	110 x 12mm	 12mm 110mm	
<b>SE:</b> TODARSE135012 <b>ST:</b> TODARST135012	135 x 12mm	 12mm 135mm	











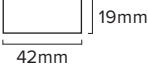

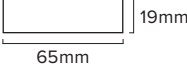

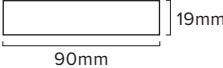

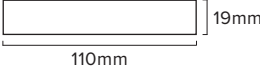

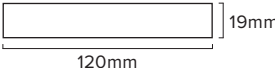

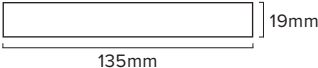



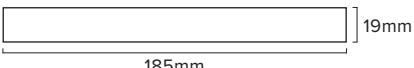

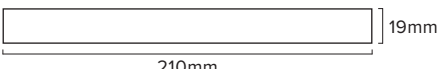

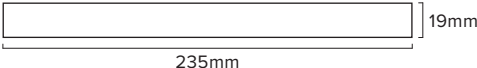
# 19mm Tasmanian Oak Hardwood

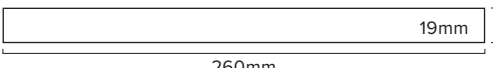
**SE** = Select Grade

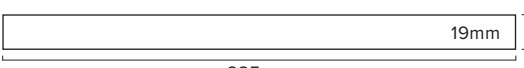
**ST** = Standard Grade

Product code	Size	Profile	3D render
<b>SE:</b> TODARSE042019 <b>ST:</b> TODARST042019	42 x 19mm	 19mm 42mm	
<b>SE:</b> TODARSE065019 <b>ST:</b> TODARST065019	65 x 19mm	 19mm 65mm	
<b>SE:</b> TODARSE090019 <b>ST:</b> TODARST090019	90 x 19mm	 19mm 90mm	
<b>SE:</b> TODARSE110019 <b>ST:</b> TODARST110019	110 x 19mm	 19mm 110mm	
<b>SE:</b> TODARSE120019 <b>ST:</b> TODARST120019	120 x 19mm	 19mm 120mm	
<b>SE:</b> TODARSE135019 <b>ST:</b> TODARST135019	135x19mm	 19mm 135mm	
<b>SE:</b> TODARSE160019 <b>ST:</b> TODARST160019	160x19mm	 19mm 160mm	
<b>SE:</b> TODARSE185019 <b>ST:</b> TODARST185019	185x19mm	 19mm 185mm	
<b>SE:</b> TODARSE210019 <b>ST:</b> TODARST210019	210x19mm	 19mm 210mm	
<b>SE:</b> TODARSE235019 <b>ST:</b> TODARST235019	235 x 19mm	 19mm 235mm	
<b>SE:</b> TODARSE260019 <b>ST:</b> TODARST260019	260 x 19mm	 19mm 260mm	
<b>SE:</b> TODARSE285019 <b>ST:</b> TODARST285019	285 x 19mm	 19mm 285mm	











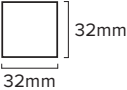

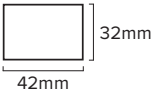

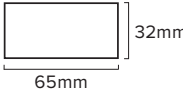

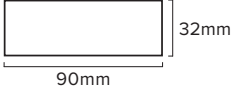

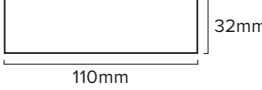



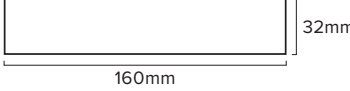

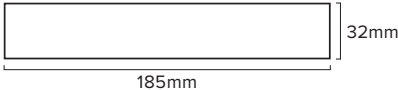

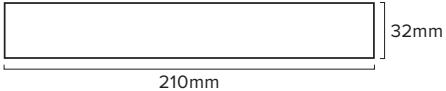
# 32mm Tasmanian Oak Hardwood

**SE** = Select Grade

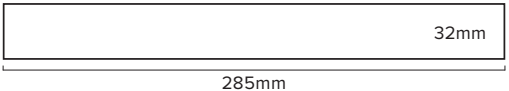
**ST** = Standard Grade

Product code	Size	Profile	3D render
<b>SE:</b> TODARSE032032 <b>ST:</b> TODARST032032	32 x 32mm		
<b>SE:</b> TODARSE042032 <b>ST:</b> TODARST042032	42 x 32mm		
<b>SE:</b> TODARSE065032 <b>ST:</b> TODARST065032	65 x 32mm		
<b>SE:</b> TODARSE090032 <b>ST:</b> TODARST090032	90 x 32mm		
<b>SE:</b> TODARSE110032 <b>ST:</b> TODARST110032	110 x 32mm		
<b>SE:</b> TODARSE135032 <b>ST:</b> TODARST135032	135 x 32mm		
<b>SE:</b> TODARSE160032 <b>ST:</b> TODARST160032	160 x 32mm		
<b>SE:</b> TODARSE185032 <b>ST:</b> TODARST185032	185 x 32mm		
<b>SE:</b> TODARSE210032 <b>ST:</b> TODARST210032	210 x 32mm		
<b>SE:</b> TODARSE235032 <b>ST:</b> TODARST235032	235 x 32mm		
<b>SE:</b> TODARSE285032 <b>ST:</b> TODARST285032	285 x 32mm		











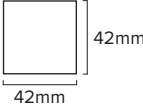

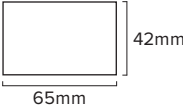

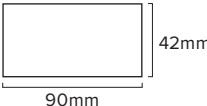



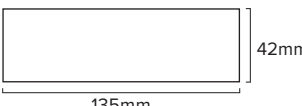

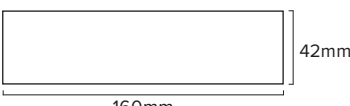

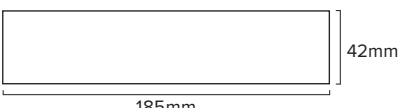
# 42mm Tasmanian Oak Hardwood

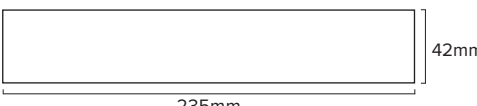
**SE** = Select Grade

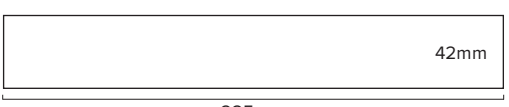
**ST** = Standard Grade

Product code	Size	Profile	3D render
<b>SE:</b> TODARSE042042 <b>ST:</b> TODARST042042	42 x 42mm		
<b>SE:</b> TODARSE065042 <b>ST:</b> TODARST065042	65 x 42mm		
<b>SE:</b> TODARSE090042 <b>ST:</b> TODARST090042	90 x 42mm		
<b>SE:</b> TODARSE110042 <b>ST:</b> TODARST110042	110 x 42mm		
<b>SE:</b> TODARSE135042 <b>ST:</b> TODARST135042	135 x 42mm		
<b>SE:</b> TODARSE160042 <b>ST:</b> TODARST160042	160 x 42mm		
<b>SE:</b> TODARSE185042 <b>ST:</b> TODARST185042	185 x 42mm		
<b>SE:</b> TODARSE235042 <b>ST:</b> TODARST235042	235 x 42mm		
<b>SE:</b> TODARSE285042 <b>ST:</b> TODARST285042	285 x 42mm		





# Abelwood Tasmanian Oak Hardwood Flooring

The timeless natural beauty of Tasmanian Oak floors provides a liveability and character which brings both old and new homes to life.

Abelwood pride themselves on the appearance and finishing qualities of their floorboards, without compromising on strength and stability.

Timber floors are easy to clean, allergy friendly and keep rooms warm in winter and cool in summer.

## Prime

---



A mild mix of natural features unique by its own nature. Choose Prime Grade in applications when a consistent flow of unique colours and mild presentation of natural characteristics are preferred.

## Classic

---



A moderate to heavy mix of natural features creating a unique floor like no other. Choose Classic Grade in applications when colour variation and natural characteristics feature frequently throughout the floor.





# Hardwood Flooring

PR = Prime Grade

CL = Classic Grade

## Flooring Profile

All Abelwood flooring uses Tongue & Groove joining profile.



## 19mm Tasmanian Oak End Matched Structural Flooring

Product code	Size	Profile	3D render
<b>PR:</b> TOFLREPR085019 <b>CL:</b> TOFLRECL085019	85 x 19mm	} 19mm 85mm	
<b>PR:</b> TOFLREPR108019 <b>CL:</b> TOFLRECL108019	108 x 19mm	} 19mm 108mm	
<b>PR:</b> TOFLREPR133019 <b>CL:</b> TOFLRECL133019	133 x 19mm	} 19mm 133mm	

## 12mm Tasmanian Oak Plain End Overlay Flooring

Product code	Size	Profile	3D render
<b>PR:</b> TOFLPPR065012 <b>CL:</b> TOFLPCL065012	65 x 12mm	} 12mm 65mm	
<b>PR:</b> TOFLPPR085012 <b>CL:</b> TOFLPCL085012	85 x 12mm	} 12mm 85mm	
<b>PR:</b> TOFLPPR112012 <b>CL:</b> TOFLPCL112012	112 x 12mm	} 12mm 112mm	
<b>PR:</b> TOFLPPR133012 <b>CL:</b> TOFLPCL133012	133 x 12mm	} 12mm 133mm	



# Abelwood Tasmanian Oak Architrave Mouldings

NSFP's mouldings are produced from high quality, sustainable hardwood timber for use particularly in architrave and skirting applications prized for their beauty, strength, stability, workability and staining qualities.

Tasmanian Oak is light in colour, varying from straw to reddish brown with intermediate shades of cream to pink. It is recognised for its excellent staining qualities, which allow ready matching with other timbers, finishes or furnishings.



**Bullnose**



**Half Splayed**



**Colonial**













**Single Bevel**

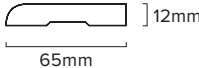

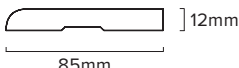



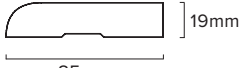



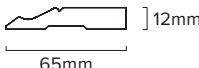

# Architrave Mouldings

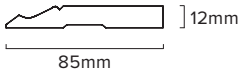
## Bullnose Architrave

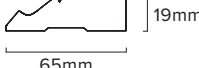

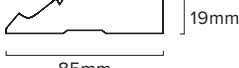



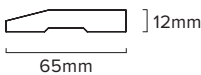

Product code	Size	Profile	3D render
TOBNAAR042012	42 x 12mm		
TOBNAAR065012	65 x 12mm		
TOBNAAR085012	85 x 12mm		
TOBNAAR065019	65 x 19mm		
TOBNAAR085019	85 x 19mm		

## Colonial Architrave

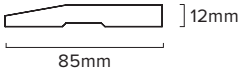



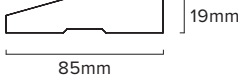





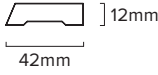

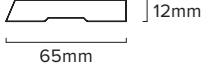
Product code	Size	Profile	3D render
TOCOAAR065012	65 x 12mm		
TOCOAAR085012	85 x 12mm		
TOCOAAR065019	65 x 19mm		
TOCOAAR085019	85 x 19mm		

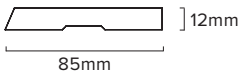

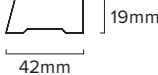
## Half Splayed Architrave

Product code	Size	Profile	3D render
TOHSAAR065012	65 x 12mm		
TOHSAAR085012	85 x 12mm		
TOHSAAR065019	65 x 19mm		
TOHSAAR085019	85 x 19mm		

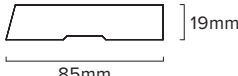
## Single Bevel Architrave

Product code	Size	Profile	3D render
TOSBAAR042012	42 x 12mm		
TOSBAAR065012	65 x 12mm		
TOSBAAR085012	85 x 12mm		
TOSBAAR042019	42 x 19mm		
TOSBAAR065019	65 x 19mm		
TOSBAAR085019	85 x 19mm		





# Abelwood Tasmanian Oak Internal Wall & Ceiling Lining

With Abelwood Internal Wall and Ceiling Lining you can achieve the perfect traditional or contemporary style for your home.





Perfectly suited for current design trends of naturally lighter tones and textures, Abelwood Tasmanian Oak Internal Linings are also extremely well suited to take stains due to the consistency of its colour and straight grain.



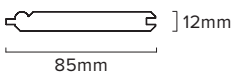

# Internal Wall & Ceiling Lining

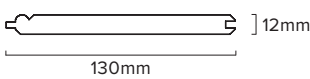
## Tasmanian Oak Regency/V-Joint Internal Lining

Product code	Size	Profile	3D render
<b>Natural:</b> TOLINRENAT085012	85 x 12mm	 ]12mm 85mm	
<b>Natural:</b> TOLINRENAT130012	130 x 12mm	 ]12mm 130mm	





# Abelwood Tasmanian Oak Door Jamb Sets

Abelwood Tasmanian Oak is prized for its beauty, strength, stability, workability and staining qualities and used extensively in door jamb componentry.

Tasmanian Oak is light in colour, varying from straw to reddish brown with intermediate shades of cream to pink. It is recognised for its excellent staining qualities, which allow ready matching with other timbers, finishes or furnishings.



# Door Jamb Sets

Abelwood Tasmanian Oak Door Jambs feature trenched heads for easy install and are available in the following profiles:



## 110x19, 2100 Height

Product code	Specifications
TODJSETSSB110019/2.11/.826	110x19x2110 .820 heads
TODJSETSSB110019/2.11/.926	110x19x2110 .920 heads
TODJSETSSB110019/2.11/1.0	110x19x2110 1.0 heads
TODJSETSSB110019/2.11/1.797	110x19x2110 1.797 heads

## 110x19, 2400 Height

Product code	Specifications
TODJSETSSB110019/2.41/.826	110x19x2410 .820 heads
TODJSETSSB110019/2.41/.926	110x19x2410 .920 heads
TODJSETSSB110019/2.41/1.0	110x19x2410 1.0 heads
TODJSETSSB110019/2.41/1.797	110x19x2410 1.797 heads

## 120x19, 2100 Height

Product code	Specifications
TODJSETSSB120019/2.11/.826	120x19x2110 .820 heads
TODJSETSSB120019/2.11/.926	120x19x2110 .920 heads
TODJSETSSB120019/2.11/1.0	120x19x2110 1.0 head





# Abelwood Tasmanian Oak and Radiata Pine Fine Mouldings

Achieve the perfect classic or contemporary look for your next project with Abelwood Tasmanian Oak and Radiata Pine Fine Mouldings.

Crafted from only the highest quality, select grade, kiln dried Tasmanian Oak hardwood timber and sustainably sourced Radiata Pine, Abelwood Fine Mouldings are available in a range of popular profiles and sizes. Abelwood Fine Mouldings offer the highest of finishes making them ready for a range of decorative options to suit your home.

**Abelwood Tasmanian Oak and Radiata Pine Fine Mouldings are available in a select range of popular profiles and sizes**



Dowel

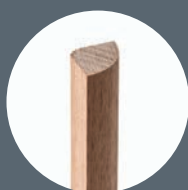

Quad



Tri-Quad

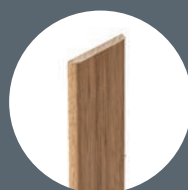

Edging

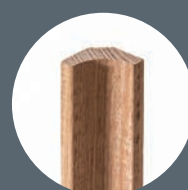

Scotia















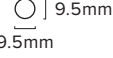

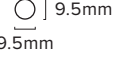

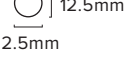

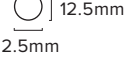
# Dowel Mouldings

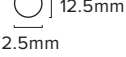
## Dowel

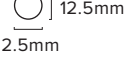

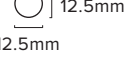





Dowel offers endless versatility and design options across a variety of decorative projects including balustrade infill components.

**TO** = Tasmanian Oak    **PN** = Radiata Pine

Product code	Size	Profile	3D render	Species	
				TAS OAK	RADIATA PINE
<b>TO:</b> TODOW0818	8mm dia Length 1.8m	 8mm 8mm		<input checked="" type="checkbox"/>	
<b>TO:</b> TODOW0824	8mm dia Length 2.4m	 8mm 8mm		<input checked="" type="checkbox"/>	
<b>TO:</b> TODOW9518	9.5mm dia Length 1.8m	 9.5mm 9.5mm		<input checked="" type="checkbox"/>	
<b>TO:</b> TODOW9524	9.5mm dia Length 2.4m	 9.5mm 9.5mm		<input checked="" type="checkbox"/>	
<b>PN:</b> PNDOW12509	12.5mm dia Length 0.9m	 12.5mm 12.5mm			<input checked="" type="checkbox"/>
<b>PN:</b> PNDOW12512	12.5mm dia Length 1.2m	 12.5mm 12.5mm			<input checked="" type="checkbox"/>
<b>TO:</b> TODOW12518	12.5mm dia Length 1.8m	 12.5mm 12.5mm		<input checked="" type="checkbox"/>	
<b>TO:</b> TODOW12524 <b>PN:</b> PNDOW12524	12.5mm dia Length 2.4m	 12.5mm 12.5mm		<input checked="" type="checkbox"/>	<input checked="" type="checkbox"/>
<b>TO:</b> TODOW12530	12.5mm dia Length 3m	 12.5mm 12.5mm		<input checked="" type="checkbox"/>	





Product code	Size	Profile	3D render	Species	
				TAS OAK	RADIATA PINE
<b>TO:</b> TODOW1618	16mm dia Length 1.8m	 16mm 16mm		<input checked="" type="checkbox"/>	
<b>TO:</b> TODOW1624	16mm dia Length 2.4m	 16mm 16mm		<input checked="" type="checkbox"/>	
<b>TO:</b> TODOW1630	16mm dia Length 3m	 16mm 16mm		<input checked="" type="checkbox"/>	
<b>PN:</b> PNDOW1909	19mm dia Length 0.9m	 19mm 19mm			<input checked="" type="checkbox"/>
<b>PN:</b> PNDOW1912	19mm dia Length 1.2m	 19mm 19mm			<input checked="" type="checkbox"/>
<b>TO:</b> TODOW1918	19mm dia Length 1.8m	 19mm 19mm		<input checked="" type="checkbox"/>	
<b>TO:</b> TODOW1924 <b>PN:</b> PNDOW1924	19mm dia Length 2.4m	 19mm 19mm		<input checked="" type="checkbox"/>	<input checked="" type="checkbox"/>
<b>TO:</b> TODOW1930 <b>PN:</b> PNDOW1930	19mm dia Length 3m	 19mm 19mm		<input checked="" type="checkbox"/>	<input checked="" type="checkbox"/>
<b>TO:</b> TODOW2524	25mm dia Length 2.4m	 25mm 25mm		<input checked="" type="checkbox"/>	
<b>TO:</b> TODOW2530	25mm dia Length 3m	 25mm 25mm		<input checked="" type="checkbox"/>	
<b>TO:</b> TODOW2918	29mm dia Length 1.8m	 29mm 29mm		<input checked="" type="checkbox"/>	
<b>TO:</b> TODOW2924	29mm dia Length 2.4m	 29mm 29mm		<input checked="" type="checkbox"/>	
<b>PN:</b> PNDOW3524	35mm dia Length 2.4m	 35mm 35mm			<input checked="" type="checkbox"/>
<b>PN:</b> PNDOW3530	35mm dia Length 3m	 35mm 35mm			<input checked="" type="checkbox"/>













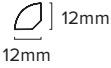

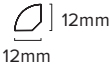

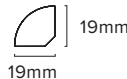
# Quad Mouldings

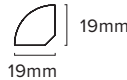
## Quad

A popular profile commonly used across internal cornering, providing a continuous rounded edge and a professional finish.

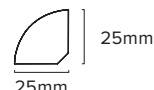
**TO** = Tasmanian Oak    **PN** = Radiata Pine

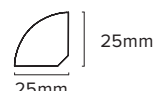

Product code	Size	Profile	3D render	Species	
				TAS OAK	RADIATA PINE
<b>TO:</b> TOQD121224 <b>PN:</b> PNQD121224	12 x 12mm Length 2.4m	 12mm 12mm		<input checked="" type="checkbox"/>	<input checked="" type="checkbox"/>
<b>TO:</b> TOQD121230 <b>PN:</b> PNQD121230	12 x 12mm Length 3m	 12mm 12mm		<input checked="" type="checkbox"/>	<input checked="" type="checkbox"/>
<b>TO:</b> TOQD191924 <b>PN:</b> PNQD191924	19 x 19mm Length 2.4m*	 19mm 19mm		<input checked="" type="checkbox"/>	<input checked="" type="checkbox"/>
<b>TO:</b> TOQD191930 <b>PN:</b> PNQD191930	19 x 19mm Length 3m*	 19mm 19mm		<input checked="" type="checkbox"/>	<input checked="" type="checkbox"/>
<b>TO:</b> TOQD191936 <b>PN:</b> PNQD191936	19 x 19mm Length 3.6m*	 19mm 19mm		<input checked="" type="checkbox"/>	<input checked="" type="checkbox"/>
<b>TO:</b> TOQD252524 <b>PN:</b> PNQD252524	25 x 25mm Length 2.4m	 25mm 25mm		<input checked="" type="checkbox"/>	<input checked="" type="checkbox"/>
<b>TO:</b> TOQD252530 <b>PN:</b> PNQD252530	25 x 25mm Length 3m	 25mm 25mm		<input checked="" type="checkbox"/>	<input checked="" type="checkbox"/>

\*Please note, both Tasmanian Oak and Radiata Pine Quad 19 x 19mm are available in random length packs.





# Tri-Quad

A popular profile commonly used in similar situations to traditional Quad and is particularly popular in finishing the edge of flooring projects.

**TO** = Tasmanian Oak    **PN** = Radiata Pine

## Tasmanian Oak Tri-Quad

Product code	Size	Profile	3D render	Species	
				TAS OAK	RADIATA PINE
<b>TO:</b> TOTQD121224	12 x 12mm Length 2.4m	12mm 12mm		<input checked="" type="checkbox"/>	
<b>TO:</b> TOTQD121230	12 x 12mm Length 3m	12mm 12mm		<input checked="" type="checkbox"/>	
<b>TO:</b> TOTQD121236	12 x 12mm Length 3.6	12mm 12mm		<input checked="" type="checkbox"/>	
<b>TO:</b> TOTQD191918	19 x 19mm Length 1.8m	19mm 19mm		<input checked="" type="checkbox"/>	
<b>TO:</b> TOTQD191924	19 x 19mm Length 2.4m	19mm 19mm		<input checked="" type="checkbox"/>	
<b>TO:</b> TOTQD191930	19 x 19mm Length 3m	19mm 19mm		<input checked="" type="checkbox"/>	

## Radiata Pine Tri-Quad

Product code	Size	Profile	3D render	Species	
				TAS OAK	RADIATA PINE
<b>PN:</b> PNTQD080824	8 x 8mm Length 2.4m	8mm 8mm			<input checked="" type="checkbox"/>
<b>PN:</b> PNTQD121224	12 x 12mm Length 2.4m	12mm 12mm			<input checked="" type="checkbox"/>
<b>PN:</b> PNTQD121230	12 x 12mm Length 3m	12mm 12mm			<input checked="" type="checkbox"/>
<b>PN:</b> PNTQD191924	19 x 19mm Length 2.4m	19mm 19mm			<input checked="" type="checkbox"/>
<b>PN:</b> PNTQD191930	19 x 19mm Length 3m	19mm 19mm			<input checked="" type="checkbox"/>











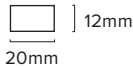

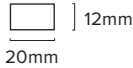

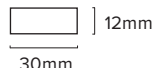

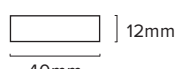
# Dressed All Round (DAR) Mouldings

## DAR Rectangle

DAR Rectangle mouldings create a contemporary finish to corners and are used commonly in decorative applications such as batten-effect walls.

**TO** = Tasmanian Oak    **PN** = Radiata Pine

Product code	Size	Profile	3D render	Species	
				TAS OAK	RADIATA PINE
<b>TO:</b> TODAR201224 <b>PN:</b> PNDAR201224	20 x 12mm Length 2.4m	 12mm 20mm		<input checked="" type="checkbox"/>	<input checked="" type="checkbox"/>
<b>TO:</b> TODAR201230	20 x 12mm Length 3m	 12mm 20mm		<input checked="" type="checkbox"/>	
<b>TO:</b> TODAR301224	30 x 12mm Length 2.4m	 12mm 30mm		<input checked="" type="checkbox"/>	
<b>TO:</b> TODAR301230	30 x 12mm Length 3m	 12mm 30mm		<input checked="" type="checkbox"/>	
<b>TO:</b> TODAR401224	40 x 12mm Length 2.4m	 12mm 40mm		<input checked="" type="checkbox"/>	
<b>TO:</b> TODAR401230	40 x 12mm Length 3m	 12mm 40mm		<input checked="" type="checkbox"/>	
<b>TO:</b> TODAR401236	40 x 12mm Length 3.6m	 12mm 40mm		<input checked="" type="checkbox"/>	
<b>PN:</b> PNDAR401824	40 x 18mm Length 2.4m	 18mm 40mm			<input checked="" type="checkbox"/>
<b>PN:</b> PNDAR401830	40 x 18mm Length 3m	 18mm 40mm			<input checked="" type="checkbox"/>













# DAR Square

DAR Square profiles are ideal for giving a contemporary finish to internal joinery corners.

**TO** = Tasmanian Oak    **PN** = Radiata Pine

Product code	Size	Profile	3D render	Species	
				TAS OAK	RADIATA PINE
<b>TO:</b> TODAR121224 <b>PN:</b> PNDAR121224	12 x 12mm Length 2.4m	 12mm 12mm		<input checked="" type="checkbox"/>	<input checked="" type="checkbox"/>
<b>TO:</b> TODAR121230	12 x 12mm Length 3m	 12mm 12mm		<input checked="" type="checkbox"/>	
<b>TO:</b> TODAR181824 <b>PN:</b> PNDAR181824	18 x 18mm Length 2.4m	 18mm 18mm		<input checked="" type="checkbox"/>	<input checked="" type="checkbox"/>
<b>TO:</b> TODAR181830 <b>PN:</b> PNDAR181830	18 x 18mm Length 3m	 18mm 18mm		<input checked="" type="checkbox"/>	<input checked="" type="checkbox"/>











# Corner Finishing Mouldings

## External Corner

The perfect profile to finish off external corners of wall lining projects.

**TO** = Tasmanian Oak    **PN** = Radiata Pine

Product code	Size	Profile	3D render	Species	
				TAS OAK	RADIATA PINE
<b>TO:</b> TOEXCR202024 <b>PN:</b> PNEXCR202024	20 x 20mm Length 2.4m	 20mm		<input checked="" type="checkbox"/>	<input checked="" type="checkbox"/>
<b>TO:</b> TOEXCR202030 <b>PN:</b> PNEXCR202030	20 x 20mm Length 3m	 20mm		<input checked="" type="checkbox"/>	<input checked="" type="checkbox"/>
<b>TO:</b> TOEXCR303024 <b>PN:</b> PNEXCR303024	30 x 30mm Length 2.4m*	 30mm		<input checked="" type="checkbox"/>	<input checked="" type="checkbox"/>
<b>TO:</b> TOEXCR303030 <b>PN:</b> PNEXCR303030	30 x 30mm Length 3m*	 30mm		<input checked="" type="checkbox"/>	<input checked="" type="checkbox"/>

\*Please note, Radiata Pine External Corner 30 x 30mm is also available in random length packs.





## Ovolo Moulding

Ovolo is the reverse profile to Scotia and can be used in similar applications.



## Scotia





Scotia is used in finishing internal corners and provides a traditional style to timber joinery projects.

**TO** = Tasmanian Oak    **PN** = Radiata Pine

### Tasmanian Oak Scotia

Product code	Size	Profile	3D render	Species	
				TAS OAK	RADIATA PINE
<b>TO:</b> TOSCO191924	19 x 19mm Length 2.4m	 19mm		<input checked="" type="checkbox"/>	
<b>TO:</b> TOSCO191930	19 x 19mm Length 3m	 19mm		<input checked="" type="checkbox"/>	
<b>TO:</b> TOSCO303024	30 x 30mm Length 2.4m	 30mm		<input checked="" type="checkbox"/>	
<b>TO:</b> TOSCO303030	30 x 30mm Length 3m	 30mm		<input checked="" type="checkbox"/>	

### Radiata Pine Scotia

Product code	Size	Profile	3D render	Species	
				TAS OAK	RADIATA PINE
<b>PN:</b> PNSCO303024	30 x 30mm Length 2.4m*	 30mm			<input checked="" type="checkbox"/>
<b>PN:</b> PNSCO303030	30 x 30mm Length 3m*	 30mm			<input checked="" type="checkbox"/>

\*Please note, Radiata Pine Scotia 30 x 30mm is also available in random length packs.











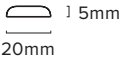

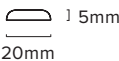



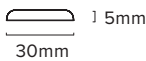

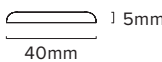

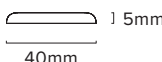

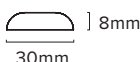
# Edging Mouldings

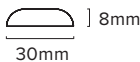
## Edging

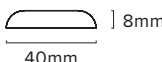
This profile offers the perfect finish to benchtop edging and cabinetry projects, its rounded edges give a professional finish to joinery applications.

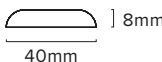
**TO** = Tasmanian Oak    **PN** = Radiata Pine

Product code	Size	Profile	3D render	Species	
				TAS OAK	RADIATA PINE
<b>TO:</b> TOEDG200524	20 x 5mm Length 2.4m	 5mm 20mm		<input checked="" type="checkbox"/>	
<b>TO:</b> TOEDG200530	20 x 5mm Length 3m	 5mm 20mm		<input checked="" type="checkbox"/>	
<b>TO:</b> TOEDG300524	30 x 5mm Length 2.4m	 5mm 30mm		<input checked="" type="checkbox"/>	
<b>TO:</b> TOEDG300530	30 x 5mm Length 3m	 5mm 30mm		<input checked="" type="checkbox"/>	
<b>TO:</b> TOEDG400524	40 x 5mm Length 2.4m	 5mm 40mm		<input checked="" type="checkbox"/>	
<b>TO:</b> TOEDG400530	40 x 5mm Length 3m	 5mm 40mm		<input checked="" type="checkbox"/>	
<b>PN:</b> PNEDG300824	30 x 8mm Length 2.4m	 8mm 30mm			<input checked="" type="checkbox"/>
<b>PN:</b> PNEDG300830	30 x 8mm Length 3m	 8mm 30mm			<input checked="" type="checkbox"/>
<b>PN:</b> PNEDG400824	40 x 8mm Length 2.4m	 8mm 40mm			<input checked="" type="checkbox"/>
<b>PN:</b> PNEDG400830	40 x 8mm Length 3m	 8mm 40mm			<input checked="" type="checkbox"/>













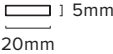

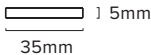

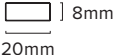

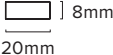



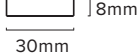

# Coverstrap Mouldings

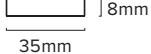
## Coverstrap

Coverstrap is a versatile profile commonly used to join wall sheet products but can also be used in a range of creative timber joinery applications.

**TO** = Tasmanian Oak    **PN** = Radiata Pine





Product code	Size	Profile	3D render	Species	
				TAS OAK	RADIATA PINE
<b>PN:</b> PNCSP200524	20 x 5mm Length 2.4m	 5mm 20mm			<input checked="" type="checkbox"/>
<b>PN:</b> PNCSP350524	35 x 5mm Length 2.4m	 5mm 35mm			<input checked="" type="checkbox"/>
<b>TO:</b> TOCSP200824 <b>PN:</b> PNCSP200824	20 x 8mm Length 2.4m	 8mm 20mm		<input checked="" type="checkbox"/>	<input checked="" type="checkbox"/>
<b>PN:</b> PNCSP200830	20 x 8mm Length 3m	 8mm 20mm			<input checked="" type="checkbox"/>
<b>TO:</b> TOCSP300818	30 x 8mm Length 1.8m	 8mm 30mm		<input checked="" type="checkbox"/>	
<b>TO:</b> TOCSP300824 <b>PN:</b> PNCSP300824	30 x 8mm Length 2.4m	 8mm 30mm		<input checked="" type="checkbox"/>	<input checked="" type="checkbox"/>
<b>TO:</b> TOCSP300830 <b>PN:</b> PNCSP300830	30 x 8mm Length 3m	 8mm 30mm		<input checked="" type="checkbox"/>	<input checked="" type="checkbox"/>
<b>PN:</b> PNCSP3508R	35 x 8mm Random length	 8mm 35mm			<input checked="" type="checkbox"/>
<b>TO:</b> TOCSP400824 <b>PN:</b> PNCSP400824	40 x 8mm Length 2.4m	 8mm 40mm		<input checked="" type="checkbox"/>	<input checked="" type="checkbox"/>
<b>TO:</b> TOCSP400830 <b>PN:</b> PNCSP400830	40 x 8mm Length 3m	 8mm 40mm		<input checked="" type="checkbox"/>	<input checked="" type="checkbox"/>



# Tasmanian Oak Mouldings





## Windmould

A Windmould is used as a external trim between the window frame and the brickwork when installing a window.

Product code	Size	Profile	3D render	Species	
				TAS OAK	RADIATA PINE
<b>TO:</b> TOWMLD301924	30 x 19mm Length 2.4m	 19mm 30mm		<input checked="" type="checkbox"/>	<input type="checkbox"/>
<b>TO:</b> TOWMLD301930	30 x 19mm Length 3m	 19mm 30mm		<input checked="" type="checkbox"/>	<input type="checkbox"/>

## Tasmanian Oak Ovolo







Ovolo is the reverse profile to Scotia and can be used in similar applications. It is also particularly popular when finishing off a dado wall project.

Product code	Size	Profile	3D render	Species	
				TAS OAK	RADIATA PINE
<b>TO:</b> TOOVL191924	19 x 19mm Length 2.4m	 19mm 19mm		<input checked="" type="checkbox"/>	<input type="checkbox"/>
<b>TO:</b> TOOVL191930	19 x 19mm Length 3m	 19mm 19mm		<input checked="" type="checkbox"/>	<input type="checkbox"/>

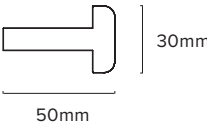

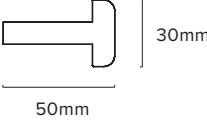
# Tasmanian Oak Astragal T Rounded

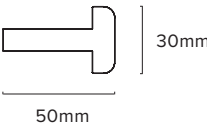
This profile is commonly used as a finishing mould between two doors. It is installed along the edge of one of the doors and provides a neat covering strip as the doors close together.

Product code	Size	Profile	3D render	Species	
				TAS OAK	RADIATA PINE
<b>TO:</b> TOAST503021	50 x 30mm Length 2.1m			<input checked="" type="checkbox"/>	<input type="checkbox"/>
<b>TO:</b> TOAST503024	50 x 30mm Length 2.4m			<input checked="" type="checkbox"/>	<input type="checkbox"/>
<b>TO:</b> TOAST503030	50 x 30mm Length 3m			<input checked="" type="checkbox"/>	<input type="checkbox"/>

# Tasmanian Oak Handrail No1

This Handrail is a modern, contemporary profile that gives a stylish look to any staircase project.

Product code	Size	Profile	3D render	Species	
				TAS OAK	RADIATA PINE
<b>TO:</b> TOHDRL01654224	65 x 42mm Length 2.4m			<input checked="" type="checkbox"/>	<input type="checkbox"/>
<b>TO:</b> TOHDRL01654230	65 x 42mm Length 3m			<input checked="" type="checkbox"/>	<input type="checkbox"/>
<b>TO:</b> TOHDRL01654236	65 x 42mm Length 3.6m			<input checked="" type="checkbox"/>	<input type="checkbox"/>





# Tasmanian Oak Bead Mouldings

## Glazing Bead No1

Glazing bead No1 is essential when installing glass into timber window frames and can also be used for any trimming or finishing use.

Product code	Size	Profile	3D render	Species	
				TAS OAK	RADIATA PINE
<b>TO:</b> TOGLB011008R	10 x 8mm Random length	10mm   8mm		<input checked="" type="checkbox"/>	

## Parting Bead

Parting Bead is essential to creating and repairing sash windows as well as having general joinery uses.

Product code	Size	Profile	3D render	Species	
				TAS OAK	RADIATA PINE
<b>TO:</b> TOPRTBD200924	20 x 9mm Length 2.4m	20mm   9mm		<input checked="" type="checkbox"/>	

## Sash Bead









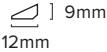

Sash Bead is designed for securing glazing panels into window frames and can also be used for any trimming or finishing use.

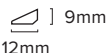
Product code	Size	Profile	3D render	Species	
				TAS OAK	RADIATA PINE
<b>TO:</b> TOSBD080824	8 x 8mm Length 2.4m	8mm   8mm		<input checked="" type="checkbox"/>	



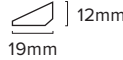



# Contemporary Mould/Bev Glaz Bead

Contemporary Mould is used as a trim when completing projects such as flooring installation and can also be used as a glazing bead for glass installations.

Product code	Size	Profile	3D render	Species	
				TAS OAK	RADIATA PINE
<b>TO:</b> TOCONMD120918	12 x 9mm Length 1.8m	 9mm 12mm		<input checked="" type="checkbox"/>	
<b>TO:</b> TOCONMD120924	12 x 9mm Length 2.4	 9mm 12mm		<input checked="" type="checkbox"/>	
<b>TO:</b> TOCONMD191236	19 x 12mm Length 3.6m	 12mm 19mm		<input checked="" type="checkbox"/>	
<b>TO:</b> TOCONMD191230	19 x 12mm Length 3m	 12mm 19mm		<input checked="" type="checkbox"/>	
<b>TO:</b> TOCONMD191224	19 x 12mm Length 2.4m	 12mm 19mm		<input checked="" type="checkbox"/>	

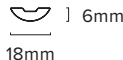
# Fly Bead

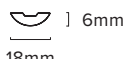
Fly bead is a round profile for installing screen mesh on timber doors and can also be used for other general trimming applications.

Product code	Size	Profile	3D render	Species	
				TAS OAK	RADIATA PINE
<b>TO:</b> TOFLBD180618	18 x 6mm Length 1.8m	 6mm 18mm		<input checked="" type="checkbox"/>	
<b>TO:</b> TOFLBD180624	18 x 6mm Length 2.4m	 6mm 18mm		<input checked="" type="checkbox"/>	



# Woodsmith™

Hand crafted  
**Tasmanian Oak Engineered Flooring**  
from nature's finest timber

## Woodsmith Product Range



Engineered Flooring Product Range





**Handcrafted from the finest hardwood Tasmanian Oak, our engineered flooring begins its life in Tasmania's arresting mountain ranges, before being planed, sanded and meticulously finished. The resource-rich, fertile environment, abundant clean air and reliable rainfall ensure a pure and consistent natural product.**

#### **A sustainable and local timber**

The regrowth eucalypt hardwood possesses a rare natural beauty, is expertly milled, ensuring waste is minimised and the yield maximised.

#### **An innovative product with a consistent grain**

The straight, consistent grain and 165mm flooring profile creates a sense of expansiveness and organic flow for a myriad of interior applications. Quarter sawing ensures a smooth, uninterrupted visual continuity. Due to the layered construction of the flooring it is stable, flexible, resistant to warping and shrinkage, and suitable for domestic and commercial applications.

Woodsmith's Tasmanian Oak engineered flooring is highly receptive to staining, resulting in a wide range of refined, contemporary colours. State of the art production techniques ensure a product that is hard wearing, highly resistant to foot traffic and every day living.

Our original, handcrafted flooring is the perfect designer choice for premium decorative themes and project choices.

[wearewoodsmith.com.au](http://wearewoodsmith.com.au)

[@wearewoodsmith](https://www.instagram.com/wearewoodsmith)

Each Woodsmith pack contains 2.1m<sup>2</sup> consisting of six boards at 2130mm long per pack (made up of three nested shorts and three long boards).







# The beauty and history of the south.

We have been producing beautiful, sustainable timber since 1924. Grown in cool climates and crafted by expert hands, Woodsmith's Tasmanian Oak engineered flooring reflects the quality and versatility of Tasmania's southern forest.

Our unrelenting commitment to value adding, design and innovation ensures there is the perfect colour choice for your next decorative project.





## Huon Trail

Tasmanian Oak in its purest form is a pale timber with a rustic charm that provides a timelessly elegant aesthetic.

### SPECIFICATIONS

Product code	TOWSEF/HUON/165014/2.130
Size	165 x 2130mm
Thickness	14.2mm
Installation Type	Tongue and Groove

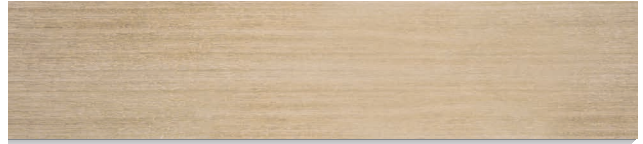

## Cradle Sky

Cradle Sky's classic, soft blonde undertone, with a twist of cool sophistication, offsets bolder accents to create a gentle ambience.

### SPECIFICATIONS

Product code	TOWSEF/CRADLE/165014/2.130
Size	165 x 2130mm
Thickness	14.2mm
Installation Type	Tongue and Groove



## Freycinet Morning

With its chic, modern tone, Freycinet Morning is perfect for a stylish industrial aesthetic, and can be creatively matched with a host of contemporary furnishings and finishes.

### SPECIFICATIONS

Product code	TOWSEF/FREYCINET/165014/2.130
Size	165 x 2130mm
Thickness	14.2mm
Installation Type	Tongue and Groove







## Tamar Mist

Tamar Mist has an understated, contemporary beauty, with a refined tone variance that assures versatility in any application.

### SPECIFICATIONS

Product code	TOWSEF/TAMAR/165014/2.130
Size	165 x 2130mm
Thickness	14.2mm
Installation Type	Tongue and Groove

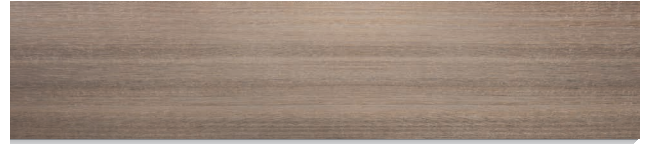

## Derwent Breeze

The timeless blonde of the natural oak is highlighted by Derwent Breeze, creating a sense of light to interior atmospheres.

### SPECIFICATIONS

Product code	TOWSEF/DERWENT/165014/2.130
Size	165 x 2130mm
Thickness	14.2mm
Installation Type	Tongue and Groove

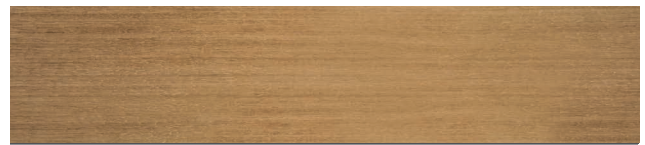

## Shannon Rise

This traditional, rich stain has a luxe character that is endlessly versatile and complements both classic and contemporary architecture.

### SPECIFICATIONS

Product code	TOWSEF/SHANNON/165014/2.130
Size	165 x 2130mm
Thickness	14.2mm
Installation Type	Tongue and Groove

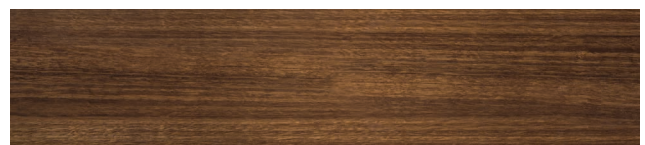





[abelwood.com.au](http://abelwood.com.au)

 [@abelwoodtasoak](https://www.instagram.com/abelwoodtasoak)

## VICTORIA

**Email:** [vicsales@nsfpgroup.com.au](mailto:vicsales@nsfpgroup.com.au)

**Phone:** +61 3 8797 1100

## TASMANIA

**Email:** [sales@nsfpgroup.com.au](mailto:sales@nsfpgroup.com.au)

**Phone:** +61 3 6326 1181